

Industry 4.0 Challenges New Capabilities in Polymer Capacitors

Key Topics

Industry 4.0, Ripple Current, Miniaturization, Battery Life, Low DL Leakage, Harsh Environmental, GaN

Industry 4.0 is the application of technology to digitally transform how industrial companies operate. These technologies include industrial IoT, automation and robotics, AI-cognitive systems, augmented reality, and big data analytics. Industry 4.0 is driven by a need to boost efficiency, become more agile to respond to market unpredictability, improve quality, and to enable new business models. This digital transformation is reshaping all manufacturing industries.

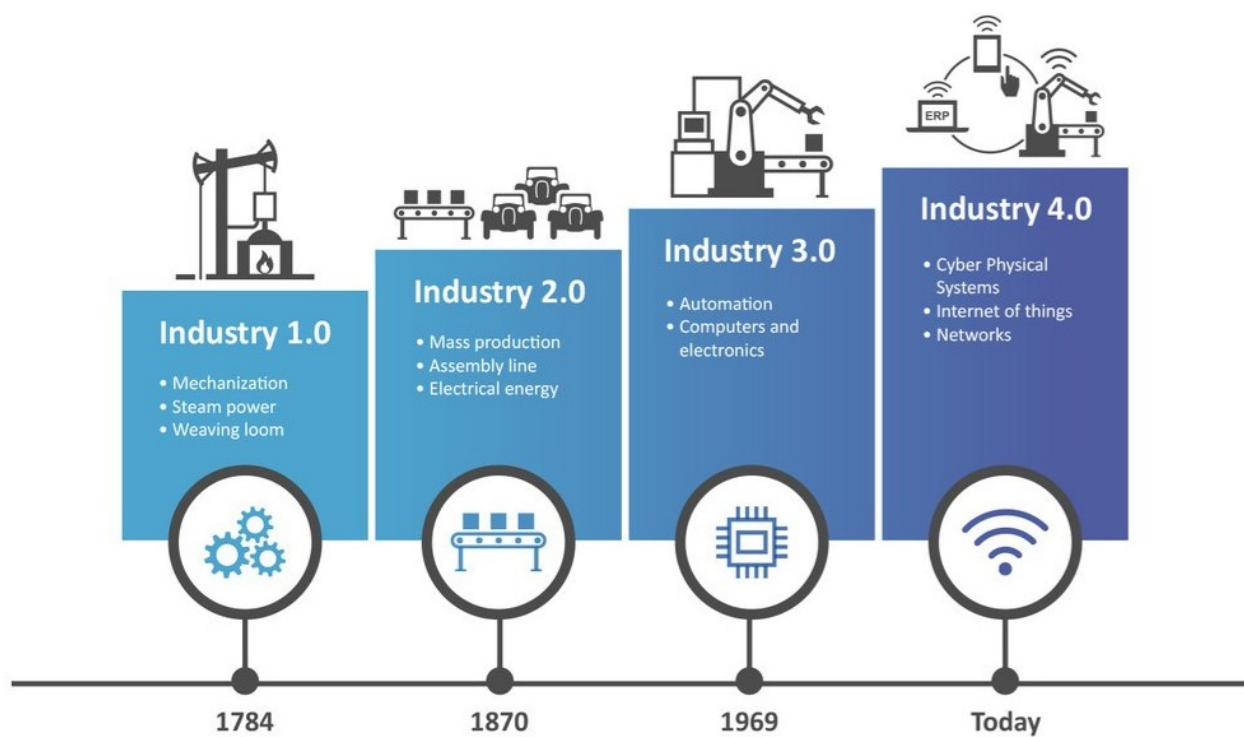

Figure 1. Industrial Evolution – source: <https://www.btelligent.com/en/portfolio/industry-40/>

The Polymer SMD Capacitors **KO-CAP®**, **NEO-CAP®**, and **AO-CAP®** offer many capabilities, including high volumetric efficiency, extended capacitance roll-off in frequency and high reliability, and extended life span. These new capabilities are essential for Industry 4.0 challenges while also supporting market segment requirements.

Extended Ripple Current Specification

KEMET updated the [T521 \(125°C\) Max Power Dissipation and Temperature Factor Correction through](#) material enhancements, thermal resistance characterization, electrical parameters stability over life endurance, and storage and ripple life testing.

Industry 4.0 Challenges New Capabilities in Polymer Capacitors

In addition, KEMET is releasing this new capacitor for the [DC/DC power conversion 12V input EIA 7343-31 220uF 16V with 125°C and 25mOhm equivalent series resistance.](#)

	P max (mW)
P max old (T521, 125°C, D case size)	225
P max new (T521, 125°C, D case size)	315

Figure 2. T521 (125°C) Maximum Power Dissipation (mW) update specification

	T521D227M016ATE025 Ripple Current (mA)			
	-55 - 45°C	85°C	105°C	125°C
Temperature Compensation Multiplier old	1	0.7	0.25	0.25
Ripple Current old (mA)	3000	2100	750	750
Temperature Compensation Multiplier new	1	1	0.7	0.25
Ripple Current new (mA)	3550	3550	2485	885

Figure 3. T521 (125°C) – T521D227M016ATE025 - Ripple Current (mA) and Temperature compensation Multiplier update

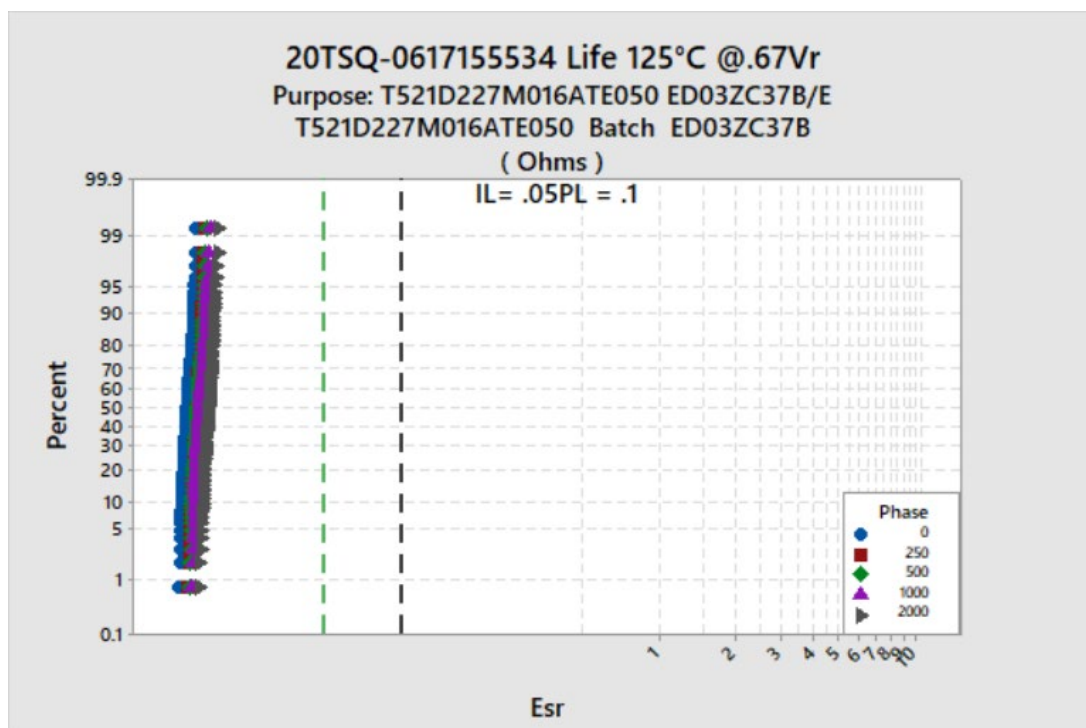

Figure 4. Endurance Life ESR Stability T521 (125°C) EIA 7343-31 220uF16V at 125°C, 10.8V up to 2000h

Industry 4.0 Challenges New Capabilities in Polymer Capacitors

Miniaturization

The downsizing trend continues to challenge capacitor manufacturers to optimize volumetric efficiency and develop new material settings that improves stability at higher temperatures. KEMET has successfully developed and is launching these capacitors during 2QCY2021, which includes the EIA 3528 47uF16V with 125°C maximum operational capability and low ESR 55mOhm. Samples are available upon request. The new footprint has 69% less actual area than the previous solution.

	Area (mm ²)	
EIA 7343 Mass Production: 47uF16V 125°	31.4	
EIA 3528 New - Launching: 47uF16V 125°	9.8	31%

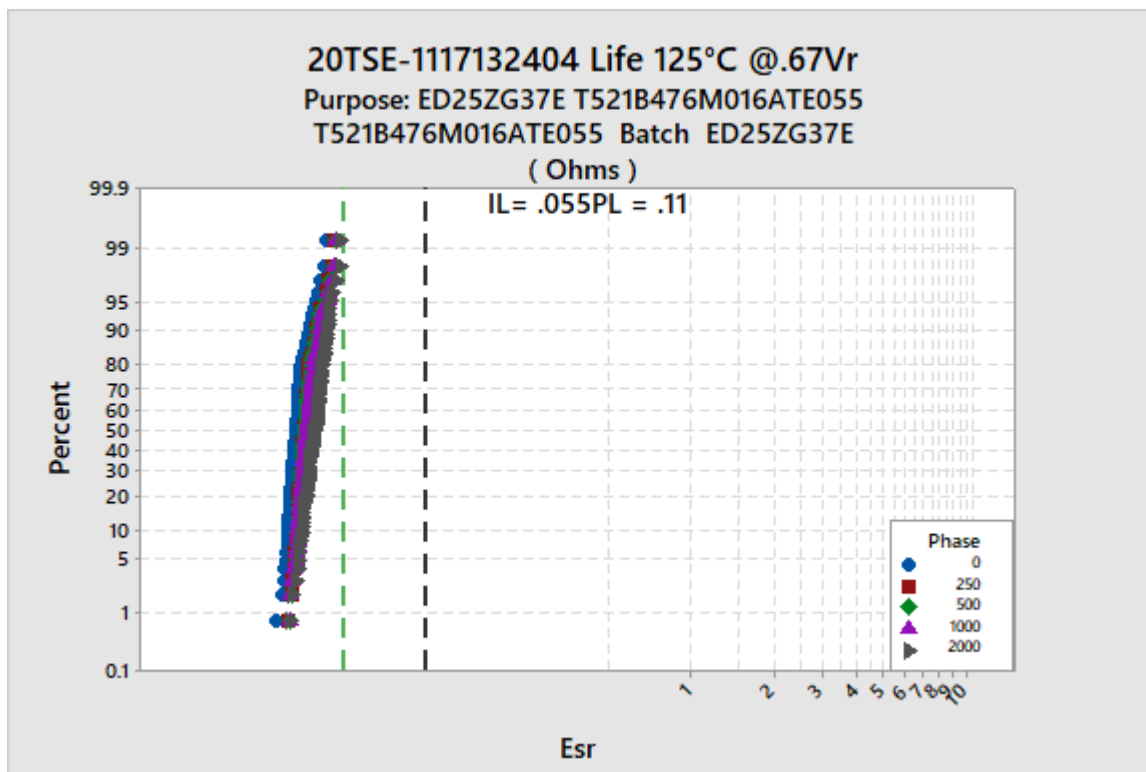

Figure 5. Endurance Life ESR Stability T521 (125°C) EIA 3528-21 47uF16V at 125°C, 10.8V up to 1000h

Industry 4.0 Challenges New Capabilities in Polymer Capacitors

Harsh Environmental Solutions in Decoupling

Digitalization and automation applications requiring low voltage decoupling, harsher operational conditions, and extended life are an opportunity for KEMET's high temperature, [high humidity-capable series A798](#) and specifically the [T591 Series Automotive Grade](#) with 500h 85°C/85%RH at rated voltage products.

	EIA Case Size
T591B227M2R5AT025 (125°C, 25mOhm)	3528-21
T591V227M2R5ATE009 (105°C, 9mOhm)	7343-20
T591D477M2R5AT006 (125°C, 6mOhm)	7343-31

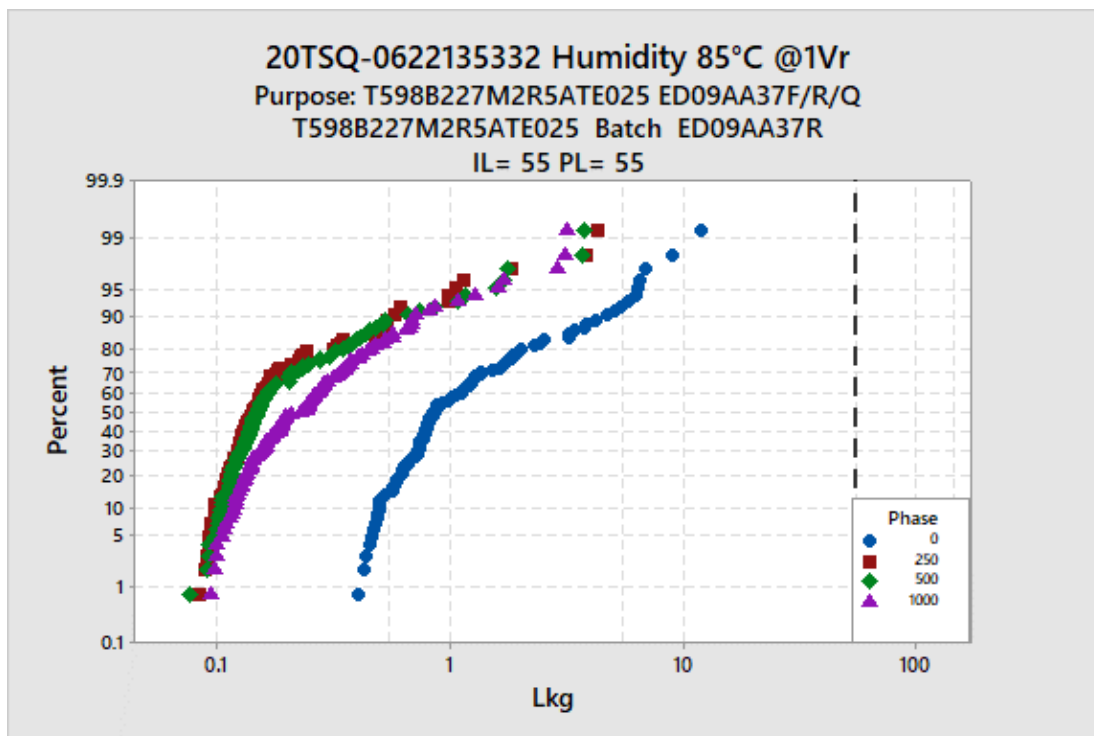

Industry 4.0 Challenges New Capabilities in Polymer Capacitors

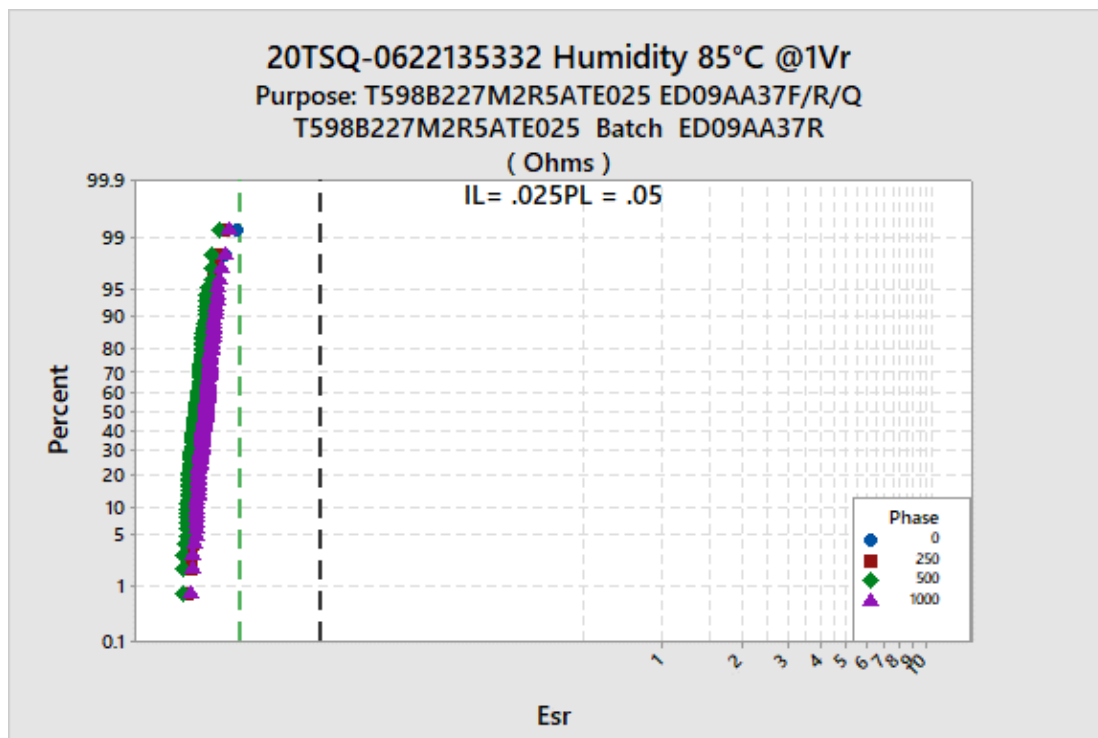

Figure 6 and 7. Example of Humidity Bias 85°C/85%RH/2,5V - DCL and ESR Stability T598 3528-20 220uF2,5V up to 1000h

Battery Life – New Low DC Leakage Specification

The latest developments in sensors and home appliance solutions require miniaturization, extended life span, and low DCL to optimize the battery usage. Polymer capacitor technology was introduced in the market almost 25 years ago with a DCL specification of $0,1 \times \text{rated capacitance} \times \text{rated voltage}$. This level of DCL is an order of magnitude higher than the legacy MnO_2 technology. Based on extensive research and development, KEMET is launching the new low DCL specification range (0.05CV and 0.03CV) during 2QCY2021.

The new part number T521X477M016ATE020 (125°C) EIA 7343-43 is the first with three levels of DCL specification. The DCL (5min, 16V, RT) comparison and the respective I-T are presented in figure 8 and 9.

T521X477M016AT*020		
E020	K020	I020
0.1CV uA	0,05CV uA	0.03CV uA
752	376	226

Industry 4.0 Challenges New Capabilities in Polymer Capacitors

I-T CURVE T521X 470UF 16V (16V, RT, UP TO 300SEC)

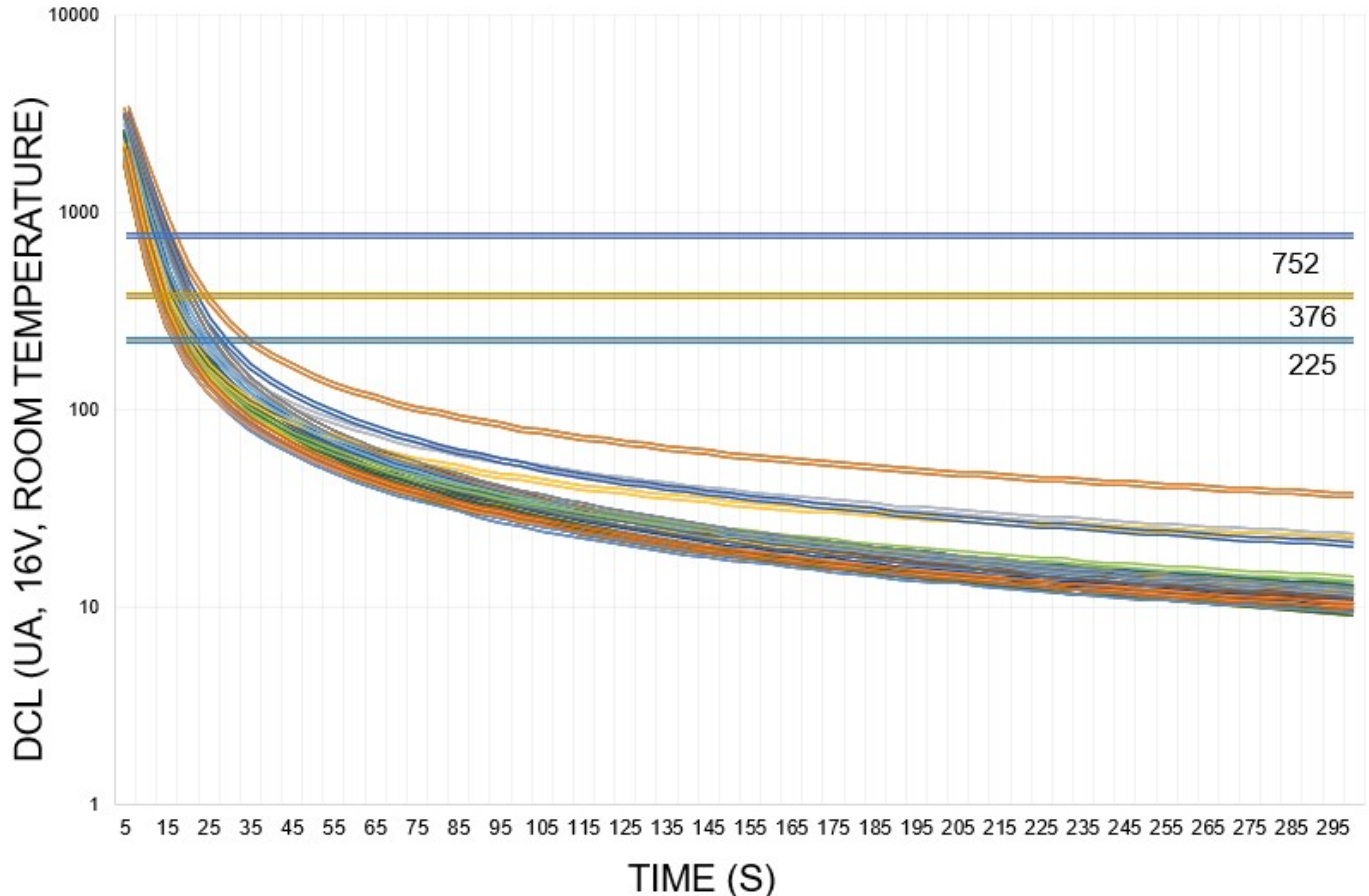

Figure 8 and 9. T521 7343-43 - New Low DCL specification offerings and the I-T curve at RT, 16V up to 300sec

The smaller case size combined with solid counter electrode technology offers extended lifespan. The new low DCL is an innovative solution for battery driven applications.

GaN Power Management Conversion

During the last 40 years, it was possible to observe a significant improvement in power management efficiency because of innovations in power MOSFETS technology, which was driven by electrical power requirements in most of our close applications with a certain slowed rate in silicon power devices as they approach their theoretical limits. HEMT (High Electron Mobility Transistor) transistors, using Gallium Nitride (GaN), appeared in the early 2000s and were successfully introduced in the market as a solution for RF applications. In 2009, the first enhanced mode gallium nitride field effect transistor (FET) was introduced in the market and designed specifically for power MOSFET replacement.

Industry 4.0 Challenges

New Capabilities in Polymer Capacitors

Assuming the basic requirements, such as high efficiency and reliability where silicon was the dominant solution for decades, power solutions saw silicon carbide and more recently gallium nitride to become the preferred platform for the future of power transistor technology. Some of the reasons for that change are presented in figure 10, which show the key electrical properties of the dominant technologies in power management solutions.

Properties	GaN	Si	SiC
E_G (eV)	3.4	1.12	3.2
E_{BR} (MV/cm)	3.3	0.3	3.5
V_S (x 10 ⁷ cm/s)	2.5	1.0	2.0
μ (cm ² /Vs)	990-2000	1500	650

Figure 10. Material properties of GaN, SiC, and silicon at room temperature

As shown in figure 10, GaN and SiC show a superior relationship between on-resistance and breakdown voltage. This allows for the devices to be smaller and the electrical terminals to be closer together for a given breakdown voltage requirement. GaN, when compared with SiC, shows another advantage with the enhanced mobility of electrons, driving additional capabilities of GaN devices with a smaller size for a given on-resistance and/ or breakdown voltage.

GaN transistors are being adopted for a wide range of applications: telecommunications, servers, laptop adapters and on-board chargers for electric vehicles, radar civil and military solutions, motor drives, and in resonant class D and class E radio frequency power amplifiers for wireless power transfer. With electricity being considered one of the basic needs of human beings today, the conventional systems for power transmission are considered high cost and show significant losses. These factors create opportunities for different solutions such as wireless power transmission (WPT), also known as inductive power transfer (IPT).

A good example of GaN technology power conversion in industrial applications is the TI PMP4486 “48Vin Digital POL” with 3 Outputs Reference Design. It is a GaN-based reference design solution using the module LMG5200 that enables a high efficiency, single stage conversion with an input range from 36 to 60V down to 29V, 12V and 1.0V with extra high efficiency up to 98.4%.

Industry 4.0 Challenges New Capabilities in Polymer Capacitors

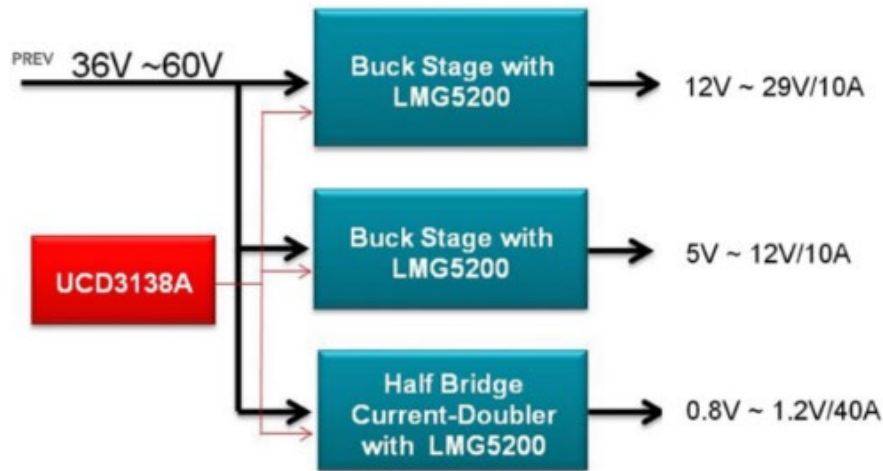

Figure 11. PMP4486 POL Reference Design – source: <https://www.ti.com/tool/PMP4486>

For the output stage of the GaN LMG5200 of 12V ~29V, reference designs offer a parallel of 4 X7R 10 μ F MLCC's 50V in parallel with an Aluminum Polymer 68 μ F 35V SMD 0.035 Ohm. This output configuration could be easily replaced by two KEMET Polymer 35V T521 series capacitors (T521X476M035ATE030), with clear advantages in terms of saving board space and providing a maximum height (low profile) solution. The KEMET polymer 47 μ F 35V X case (7343-43) offers a very low and flat ESR performance over frequency and a suitable derating recommendation of 10% up to 105 $^{\circ}$ C, making it a perfect solution for industrial applications.

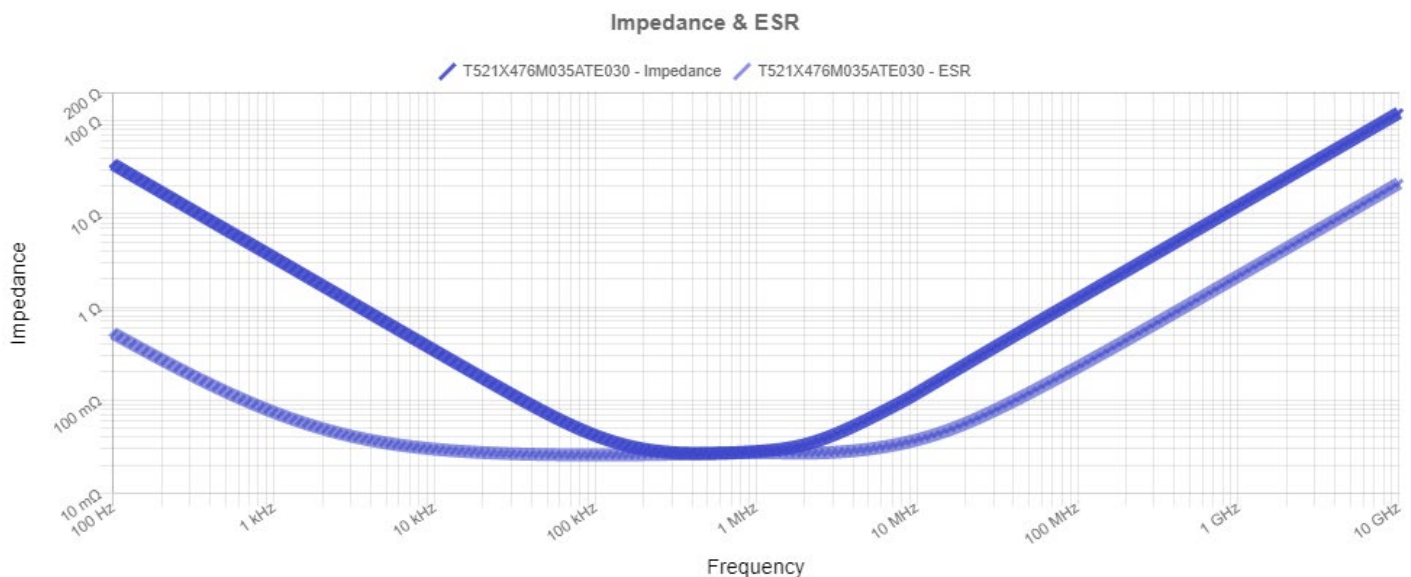

Figure 12. ESR behavior over frequency

Industry 4.0 Challenges New Capabilities in Polymer Capacitors

Polymer technology can offer capacitance solutions for power management where:

- Large capacitance/bulk capacitance is required
- Reduced PCB area is available
- A low profile solution is required
- Applications are not compatible with MLCCs' acoustic noise

Conclusions

New polymer technology capabilities offer potential solutions in industrial applications where board space-saving, high volumetric efficiency/miniaturization, life span, and reliability are required. Please contact a [KEMET sales representative](#) to help find a solution to your challenges.

Cristina Mota Caetano
Director, Technical Product Marketing – Tantalum BG
cristinacaetano@kemet.com

March 2021