

Understanding Polymer and Hybrid Capacitors

Advanced capacitors based on conductive polymers maximize performance and reliability

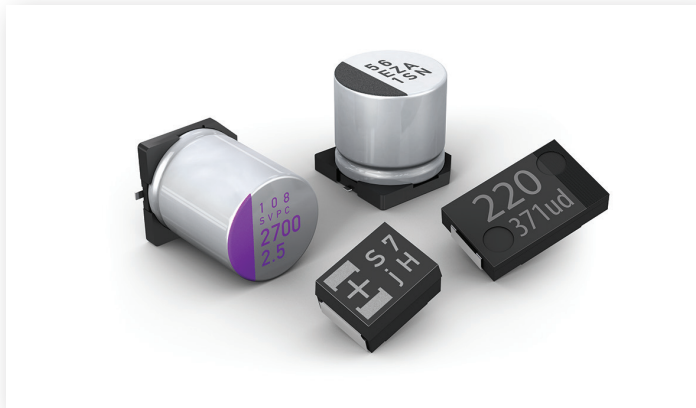

Hybrid capacitor technology combines the performance benefits of electrolytic and polymer capacitors.

Capacitors may seem simple enough, but specifying them has actually grown more complex in recent years. The reason why comes down to freedom of choice. The universe of capacitors has expanded greatly over the past few years, in large part because of capacitor designs that take advantage of advances in conductive polymers.

These advanced capacitors sometimes use conductive polymers to form the entire electrolyte. Or the conductive polymers can be used in conjunction with a liquid electrolyte in a design known as a *hybrid capacitor*. Either way, these polymer-based capacitors offer a performance edge over conventional electrolytic and ceramic capacitors when it comes to:

- Electrical characteristics.
- Stability.
- Longevity.
- Reliability.
- Safety.
- Life cycle cost.

The various polymer and hybrid capacitors have distinct sweet spots in terms of their ideal voltages, frequency characteristics, environmental conditions and other application requirements. In this paper, we'll show you how to identify the best uses for each type of advanced capacitor. We'll also highlight specific applications in which a polymer or hybrid capacitor will outperform traditional electrolytic or even ceramic capacitors.

POLYMER CAPACITOR VARIETIES

Polymer capacitors come in four main varieties, including the hybrid. Each type has different electrolytic and electrode materials, packaging and application targets:

- **Layered polymer aluminum capacitors** use conductive polymer as the electrolyte and have an aluminum cathode (see Figure 1). Depending on the specific model, these capacitors cover a voltage range from 2-35V and offer capacitances between 2.2-560 μ F. The distinguishing electrical characteristic of these polymer capacitors is their extremely low equivalent series resistance (ESR). For example, some of our SP-Cap™ polymer capacitors have ESR values as low as 3m Ω , which is among the lowest in

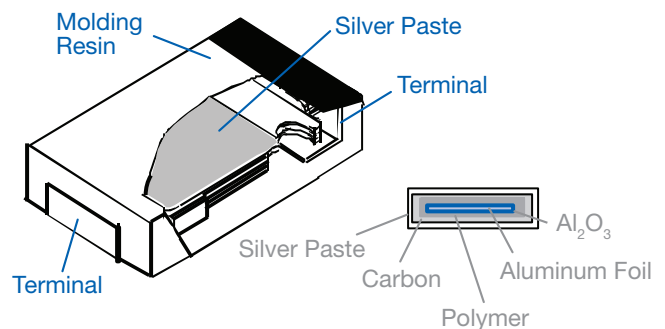

Figure 1

the industry. Packaged in a molded resin as compact surface mount devices, these layered polymer capacitors have a low profile. As a result of the electrical and form factor characteristics, they have applications in a variety of handheld electronic devices or other applications that require a low-profile capacitor that will not interfere with a nearby heat sink.

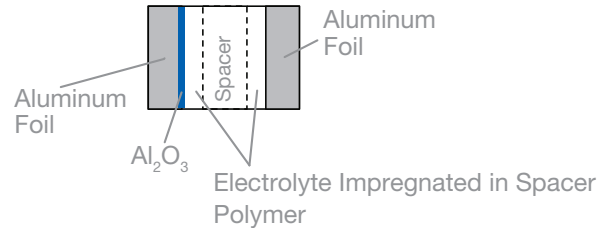
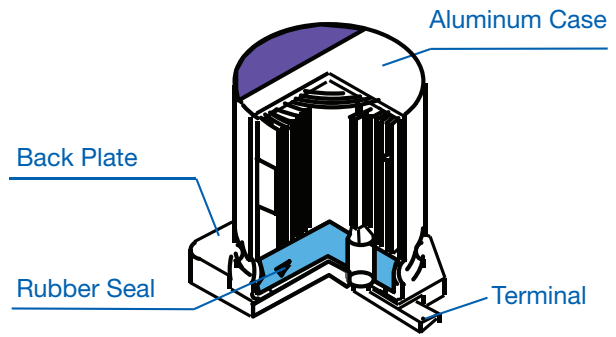

Figure 2

- Wound polymer aluminum capacitors** are also based on conductive polymers and aluminum, but they have a wound foil structure (see Figure 2). The wound polymer capacitors cover a wider range of voltages and capacitance values than other types of polymer capacitors. Voltages extend from 2.5 to 100V, while capacitances run from 3.3 to 2700 μ F. Like the layered polymer capacitors, the wound style has extremely low ESR values. Some of our OS-CON™ capacitors, for instance, have ESR values below 5m Ω . The wound style can also be surface mounted, though they are not quite as compact as the layered capacitors.

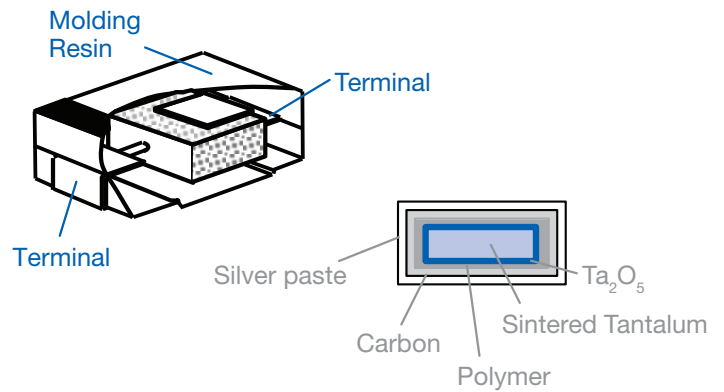

Figure 3

- Polymer tantalum capacitors** employ a conductive polymer as the electrolyte and have a tantalum cathode (see Figure 3). They span voltages from 2 to 35V and capacitances from 3.9 to 1500 μ F. They, too, have low ESR values. They, too, have low ESR, with some of our POSCAP™ capacitors exhibiting ESR values as low as 5m Ω . Packaged in a molded resin case, the tantalum polymer capacitors are among the most compact on the market. Our POSCAP M size, for example, measures just 2.0 by 1.25 mm. Though compact, a wide range of sizes is available for this capacitor type.



- Polymer hybrid aluminum capacitors.** As their name suggests, these capacitors use a combination of a liquid and conductive polymer to serve as the electrolyte (see Figure 4) and aluminum as the cathode. Think of this technical approach as the best of both worlds: The polymer offers high conductivity—and a correspondingly low ESR. The liquid portion of the electrolyte, meanwhile, can withstand high voltages and provide higher capacitance ratings due to its large effective surface area. The hybrid capacitors offer a voltage range from 25 to 80V and capacitances between 10 and 330 μ F. At 20 to 120m Ω , ESR values for hybrids are higher than other types of polymer capacitors, but still very low considering the higher power applications they address (see sidebar).

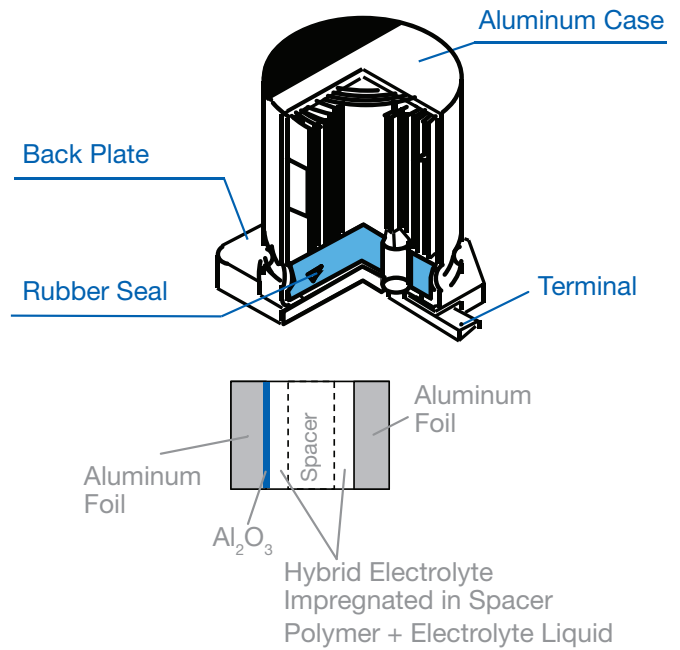

Figure 4

POLYMER CAPACITOR ADVANTAGES

Despite differences in their materials and construction, the four types of polymer capacitors share a collection of desirable electrical properties:

- Great frequency characteristics.** Thanks to their ultra low ESR values, polymer capacitors have a low impedance near their resonance point (see Figure 5). And lower impedance reduces AC ripple in power circuits. Our testing has

Figure 5

ESR lowers impedance near the resonance point, reducing AC ripple.

IMPEDANCE CHARACTERISTICS

Impedance
 Capacitance: $\frac{1}{2\pi fC}$
 Inductance: $2\pi fL$, where $L = ESL$
 Resistance: ESR

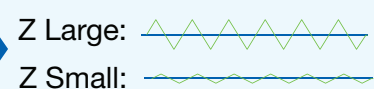
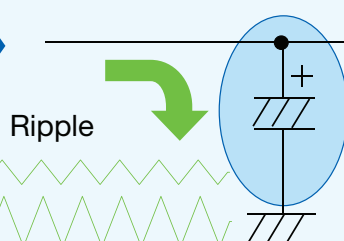
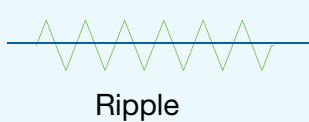
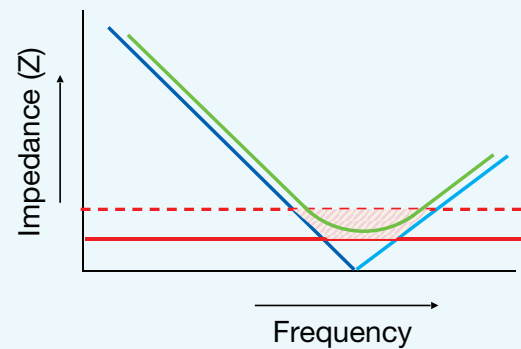
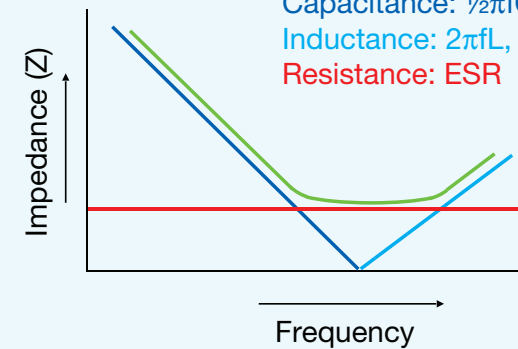

Reliable Capacitors For IT Infrastructure

Information technology infrastructures have a little-known weak link: The capacitors in their power supplies.

Conventional electrolytic capacitors tend to fail prematurely when their liquid electrolyte dries up, which happens in response to elevated temperatures and long on times.

Conventional tantalum capacitors are one possible solution to these premature failures. However, tantalums require voltage derating to avoid a very undesirable failure mode—namely, the potential for fires.

More advanced polymer-based capacitors have emerged as a way to improve lifecycle and reliability of IT equipment such as servers, switches, routers and modems.

Polymer wound capacitors such as OS-CON do not have a liquid electrolyte and therefore can have extremely long life.

POSCAP polymer-tantalum capacitors contain no oxygen in their formulation. So they are not prone to combustion upon failure. SP-Caps also have a similar benign failure mode.

All three families of advanced capacitor also offer the features required for information infrastructure:

- Compact size.
- Low ESR
- High Ripple Current
- Long Life.

revealed as much as a fivefold reduction in peak-to-peak voltage changes when comparing polymer capacitors to conventional low-ESR tantalum capacitors.

- **Stable capacitance.** With ceramic capacitors, capacitance drifts in response to temperature changes and DC bias. Polymer capacitors have no such problem and remain stable over time (see Figure 6). This stability is particularly important in industrial and automotive applications, which tend to experience fluctuations in operating temperatures. We've seen cases where elevated temperatures caused an effective capacitance loss of 90% or more for ceramic capacitors, meaning that the conventional capacitors

STABLE CAPACITANCE

DC Bias

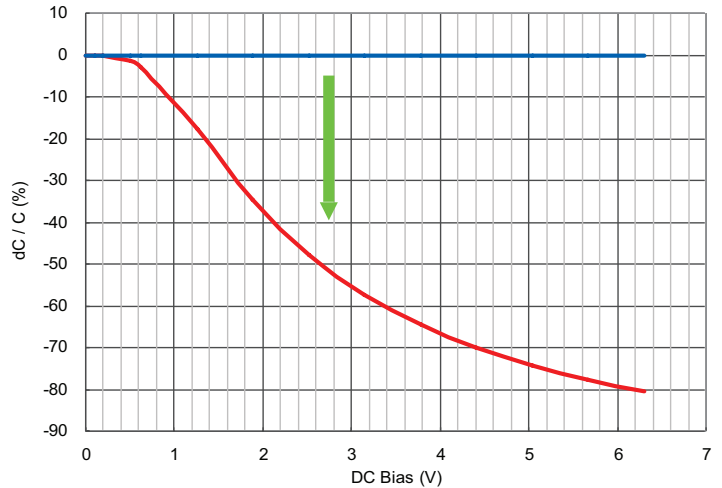

Temperature Range

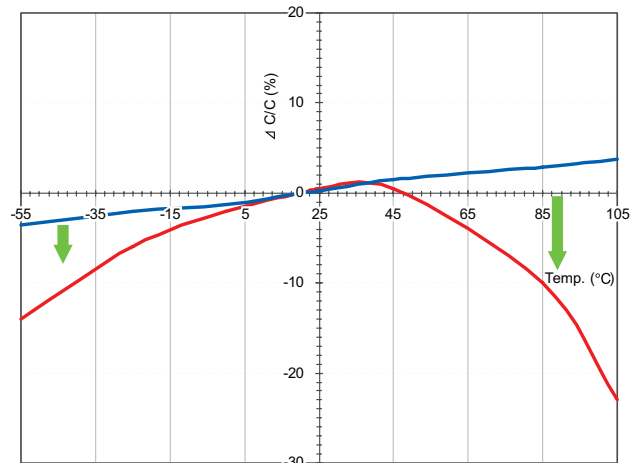

- **MLCC**
Multilayer ceramic capacitor (6.3V47μF/3216/X5R)
- **Polymer capacitor**
POSCAP, SP-Cap or OS-CON (6.3V47μF)

Figure 6

deliver subpar performance in the field. Hybrid capacitors add another dimension to capacitance stability. They keep a stable capacitance in the face of common operating conditions—high frequencies and low temperatures—that reduce the capacitance of conventional liquid electrolytic capacitors.

(see Figure 7).

- **Enhanced safety.** Conventional electrolytic capacitors can suffer from safety issues that could cause them to short circuit and fail. The problem arises when electrical or mechanical stresses create defects or discontinuities in the oxide film that forms the capacitor's dielectric. Polymer

capacitors have a self-healing capability that eliminates this failure mode. The repair takes place in response to the joule heating that occurs when a dielectric defect triggers a short circuit. The heating breaks the molecular chain of the conductive polymer near the defect, driving up its resistance and effectively forming a barrier against any current leaking from the electrode (see Figure 8). In the case of hybrid capacitors, an additional self-healing mechanism comes into play—because the liquid electrolyte causes current flow near the defect to reoxidize the aluminum. We have conducted numerous over-voltage tests to demonstrate the self-repairing nature of polymer and hybrid capacitors. One such test compared our SP-Cap polymer capacitors to a conventional tantalum-MnO₂ capacitors. The polymer model withstood short currents as high as 7 amps, while the tantalum capacitor started smoking at 3 amps and ignited at 5 amps. This safety enhancement has important design and cost implications. Conventional tantalum capacitors are normally derated in use by 30 to 50% their labeled voltage to ensure that they operate safely. This derating, while a common and accepted engineering practice, results in an upsizing of capacitors and increased cost. For our polymer capacitors, by contrast, we guarantee operation at 90% of the full-rated voltage.

Polymer And Hybrid Capacitors Are Road Ready

Polymer capacitors are seeing increasing use in automotive electronic applications. Our polymer and hybrid capacitors meet the following automotive production requirements:

- OS-CON, Hybrid and POSCAP models comply with **AEC standards**.
- Capacitors are produced in a **TS16949 certified** production facility.
- **Production Part Approval Process (PPAP)**.



HYBRID CAPACITOR PERFORMANCE

Capacitance vs. Frequency

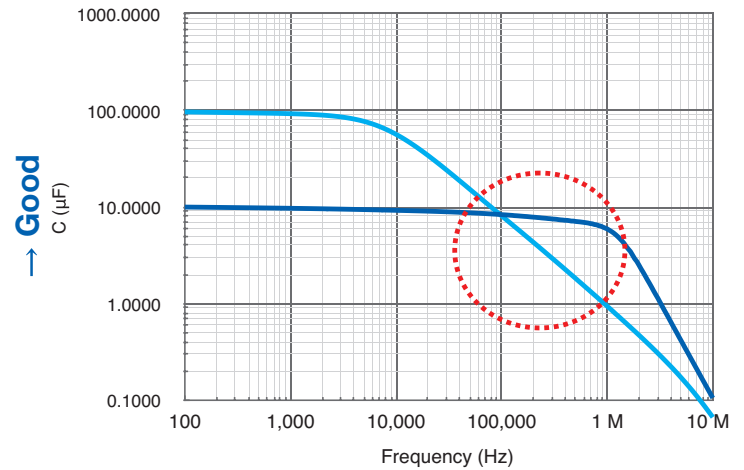

Hybrid capacitors offer stable capacitance at high frequencies.

ESR vs. Temperature

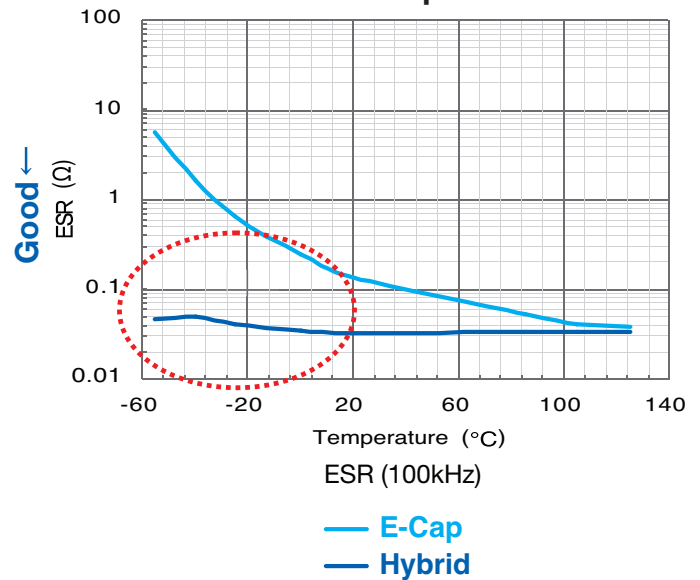

Hybrid capacitors offer stable ESR even at temperatures as low as -55°C.

Figure 7

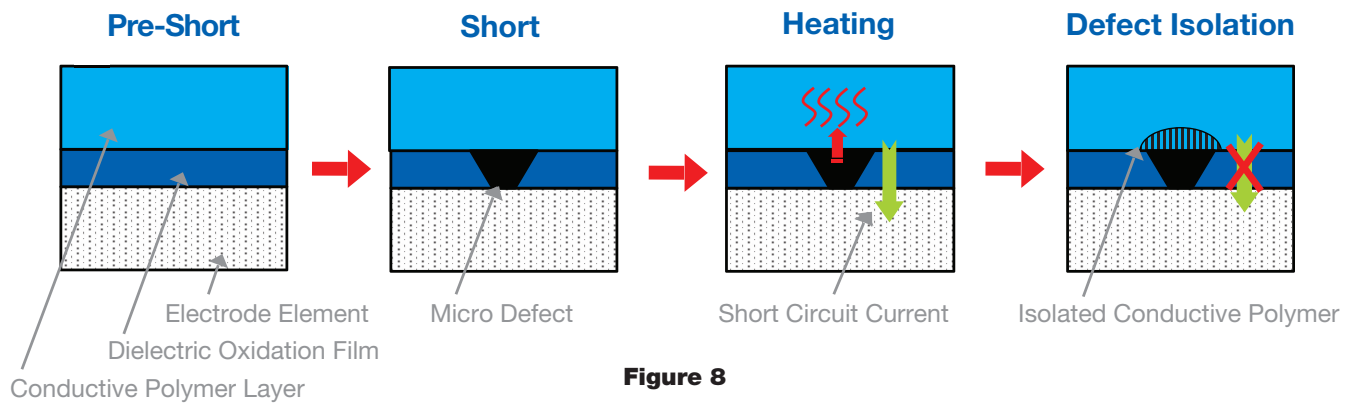

Polymer capacitors have been in production since 1990. But they continue to evolve, both in terms of their electrical characteristics and their sizing. Consider our aluminum polymer capacitor line, for example. Upcoming models will drive ESR even lower and capacitance even higher—to 2mΩ and 680μF, respectively. Or looking at the tantalum polymer line, new models will offer reductions in ESR in smaller surface mount packages. For example, the 3.5x2.8-mm B-Size capacitors will likely see a drop in ESR from 9 to 6mΩ.

Our hybrid capacitor line is evolving too. We are expanding the voltage coverage with new 16 and 100V capacitors. Life cycle and ripple current specifications are also slated for improvement in upcoming product releases.

These continuous technical improvements will make polymer and hybrid capacitors an increasingly attractive alternative to conventional tantalum-MnO₂ and multi-layer ceramic capacitor (MLCC) technologies.

Robust Capacitors For Industrial Use

The increased use of electronics in industrial applications has created a need for more robust capacitor solutions. These demanding applications often have unforgiving operating environments that are not friendly to conventional capacitor technology such as aluminum electrolytics.

Capacitors utilizing polymer technology, such as our OS-CON and Hybrid models, are ideally suited for these applications because they offer a combination of:

- Long Life
- Low ESR
- High Ripple Current
- High Temperature
- High Voltage
- High Capacitance

Industrial applications that can benefit from advanced polymer and hybrid capacitors include motor drives, power inverters and specialty lighting.

Controller applications can take advantage of polymer-based capacitors too. Our POSCAP polymer tantalum and SP-Cap models have all the electrical characteristics we just mentioned but also have compact form factors that make it easy to integrate them in industrial control systems.

Hybrid Capacitor Performance Advantages

Driven by miniaturization of electrical components and higher switching frequencies of many electrical devices, hybrid capacitors have started to get more traction.

Hybrids are known for their stable electrical characteristics at high frequencies. These robust capacitors also have other compelling advantages that make a difference in applications such as computer servers, backup devices and networking gear as well as industrial motors, automotive engine control units, security cameras and LED lighting. Among the advantages:

Hybrids are compact. Given the ongoing push to miniaturize electrical equipment, the size of capacitors has taken on a growing importance. Surface mount hybrid capacitors measuring just 6.3 x 5.8 mm can handle 35V and offer a capacitance of 47 μ F. The small size can save a significant amount of board space. In a recent 48V power supply application, hybrid capacitors occupied just 13% of the board space required by aluminum electrolytic capacitors.

Hybrids maximize reliability. Capacitors cannot just be small, they also need to hold up under challenging electrical and environmental conditions. By nearly every measure, hybrid capacitors outperform equivalent aluminum electrolytic and polymer capacitors hands down. To take a few examples, hybrid capacitors have significantly better endurance and humidity resistance than either their electrolytic or polymer counterparts. Hybrids also have significantly higher tolerance for large ripple currents, inrush currents and elevated temperature (See Figure 9).

Taken together, the size and reliability produce a strong cost benefit for using hybrid capacitors—in spite of their higher upfront prices. The higher ripple current specification alone can result in a 20% reduction in cost by increasing the life cycle of the capacitor. In the 48V power supply application we just mentioned, the hybrid capacitors had a total cost 50% lower than the equivalent aluminum electrolytic capacitors, with the savings coming from reductions in board cost, warranty cost and ability to withstand high ripple current.

Figure 9
Hybrid capacitors exhibit high reliability when subjected to high ripple currents. In recent testing, the capacitors had the electrical characteristics at no load and rated ripple current (1300 mA) conditions. At three times the rated ripple current (3600 mA), the capacitor's electrical characteristics did change, but no shortage took place.

